

## Ersatzteile und Zubehör • Spare parts and accessories • Pièces détachées et accessoires • Parti di ricambio e accessori • Piezas de recambio y accesorios

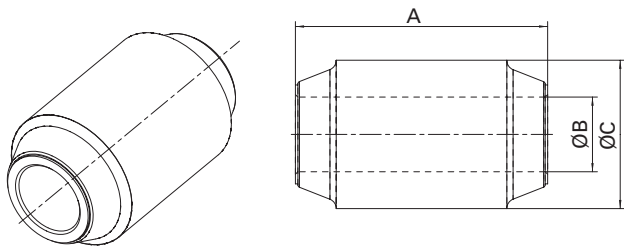

Ersatzteile und Zubehör • Spare parts and accessories • Pièces détachées et accessoires • Parti di ricambio e accessori • Piezas de recambio y accesorios

	A (mm)	B (mm)	C (mm)
Y 059037009	82	30	60,3
Y 059037109	102	30	60,3
Y 059037209	102	32	60,3

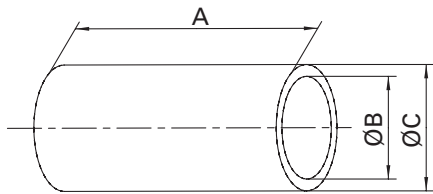

Lagerbuchsen: (Messing) • Bearing bushes: (brass) • Douilles de palier: (laiton) • Gusci di cuscinetto: (in ottone) • Casquillos de cojinete: (latón)

	A (mm)	B (mm)	C (mm)
Y 018035509	70	26	32
Y 018018409	80	28	34
Y 018018509	100	30	36
Y 018039109	100	32	38
Y 018042509	100	40	45
Y 018075509	80	26	32

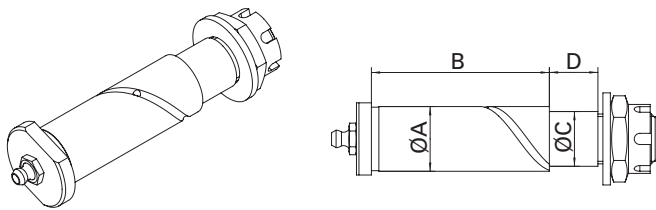

Lagerbolzen Form A: (abgesetzt) • Bearing bolt form A: (extended with different diameter) • Axe de crochet A: (étagé) • Perno ganascia forma A: (fissato) • Bulón de articulación forma A: (recortado)

	A (mm)	B (mm)	C (mm)	D (mm)
Y 016388009	70	26	92,5	22
Y 016388109	80	28	107,5	24
Y 016388209	100	30	131,5	26

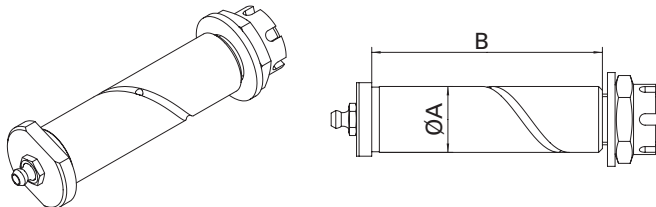

Lagerbolzen Form B • Bearing bolt form B • Axe de crochet, forme B • Perno ganascia forma B • Bulón de articulación forma B

	A (mm)	B (mm)
Y 016388309	70	110
Y 016388409	80	130
Y 016388509	100	160
Y 016387009	100	160

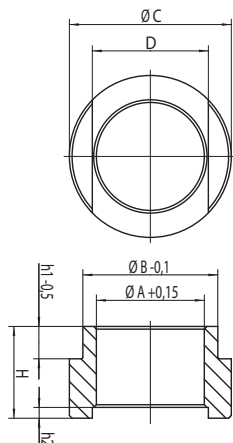

Anschweißaugen • Welding eyes • Oeilletts de soudure • Occhi saldati • Succión de la soldadura

	A (mm)	B (mm)	C (mm)	H (mm)	h1	D	h2
Y 016388609	22	38	42	21	10	–	–
Y 016388709	26	38	42	21	10	–	–
Y 016388809	26	38	42	25	10	29	4
Y 016388909	24	44	48	26	12	–	–
Y 016389009	28	44	48	26	10	–	–
Y 016389109	28	44	48	30	10	31	4
Y 016389209	26	44	50	30	12	–	–
Y 016389309	30	44	50	30	12	–	–
Y 016389409	30	44	50	34	12	33	4
Y 016389509	40	50	55	30	12	–	–
Y 016389609	40	50	55	34	12	43	4

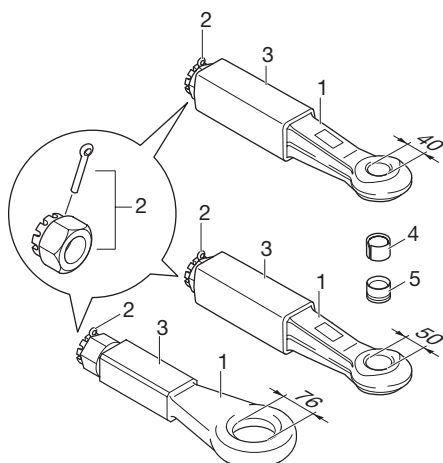

Ersatzteile und Zubehör • Spare parts and accessories • Pièces détachées et accessoires • Parti di ricambio e accessori • Piezas de recambio y accesorios

		∅ (mm)	
1	ROE 57319	40	
1	ROE 57322	50	
1	ROE 57303	76	
2	ROE 56049	40/50/76	
3	ROE 53435	40/50/76	
4	ROE 53051	40	
4	ROE 53004	50	
5	ROE 53386	40	
5	ROE 53376	50	
5	ROE 53556	57,5 R	
5	ROE 53611	57,5 V	

Übermaßbuchsen • Oversize bushes • Douilles à sur-mesure • Bussole maggiorate • Casquillos de sobremedida

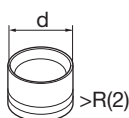

a = 40 mm

	d (mm)	R
ROE 53206	48,5	1
ROE 53207	49	2
ROE 53208	49,5	3
ROE 53209	50	4



a = 50 mm

	d (mm)	R
ROE 53362	60,5	1
ROE 53363	61	2

Prüflehren (Kupplungsbolzen und Zugösen) • Wear gauge (Coupling pin and towing eye) • Gabarits (axes d'accouplement et anneaux de remorquage) • Calibri di controllo (perni e occhioni di traino) • Calibres de referencia (perno de acoplamiento y puntas de lanza)



	(mm)	
ROE 57026	30 (LoF), 40	
ROE 57122	50 (ISO)	
ROE 71354	57	



Montagedorn zum Ein- und Ausschlagen von Zugösenbuchsen • Mounting tool for hammering in and removing towing eye bushes • Broche de montage pour enfoncer et ressortir les douilles des anneaux de remorquage • Spina di montaggio per inserire e estrarre le bussole dell'occhione • Cuña de montaje para introducir y sacar los casquillos de las puntas de lanza

	∅ (mm)	
ROE 57111	40	
ROE 57228	50	

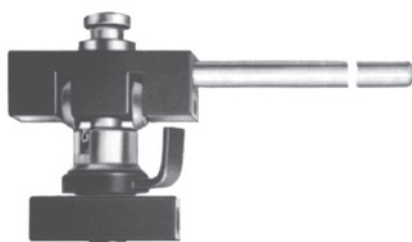

Einroll-Werkzeug für Zugösenbuchsen • Rolling-in device for towing eye bushes • Outil de roulage pour les douilles des anneaux de remorquage • Avvolgitore per le bussole dell'occhione • Herramienta de introducción de casquillos de puntas de lanza

	∅ (mm)	
ROE 57059	40	
ROE 57088	50	